

Cooker hob Elettra



Gas hobs

Code: 7064 062



DETAILS

Edge/Installation Type Standard (8 mm Edge)

Finish Foster brushed

Material AISI 304 stainless steel

Texture Brushed in line

Supply 220 - 240 V; 50/60 Hz

Dimensions 760x500 mm

Base size 60 cm

Heating element Five burners

Built-in hole 560 x 480 mm

Grids Cast iron grids and enamelled burner covers

Width 76 cm

Total power 10.700 W

Auxiliary 1.000 W

Semirapid 2 x 1.750 W

Rapid 2.700 W

Triple crown 3.500 W

Safety Safety valve with quick-acting thermocouple

Ignition Electric ignition under knob

Gas type Tested for installation with natural gas, LPG nozzle set included.

Type Gas Hob

FEATURES

Cast iron grids Cast-iron is the ideal material for an hob grid, this due to the manifold properties characterising it: high heat capacity that improves cooking performance; high weight and stability that improve safety; sturdiness that preserves the hob's original aspect over time; easy cleaning.

Safe cooking All Foster cooker hobs are equipped with safety valves. They shut off the gas supply very quickly if the flame accidentally goes out.

Special burners

Many Foster hobs are equipped with special burners, with two or three rings of fire that greatly increase the power delivered and the heated surface. In the DUAL models the two fire crowns also have independent ignition, making these burners perfect for both intensive and delicate cooking.

Under-knob ignition

The utmost freedom of movement with electronic under-knob ignition, a common feature of all models that allows a one-hand ignition of the burner.

Narrow cut-out

These 5 burners products for standard built-in installation require a cut-out of only 56 cm, i.e. less than their nominal width. This makes them an interesting alternative for 60 cm models, which usually require the same cut-out.

TECHNICAL DATA

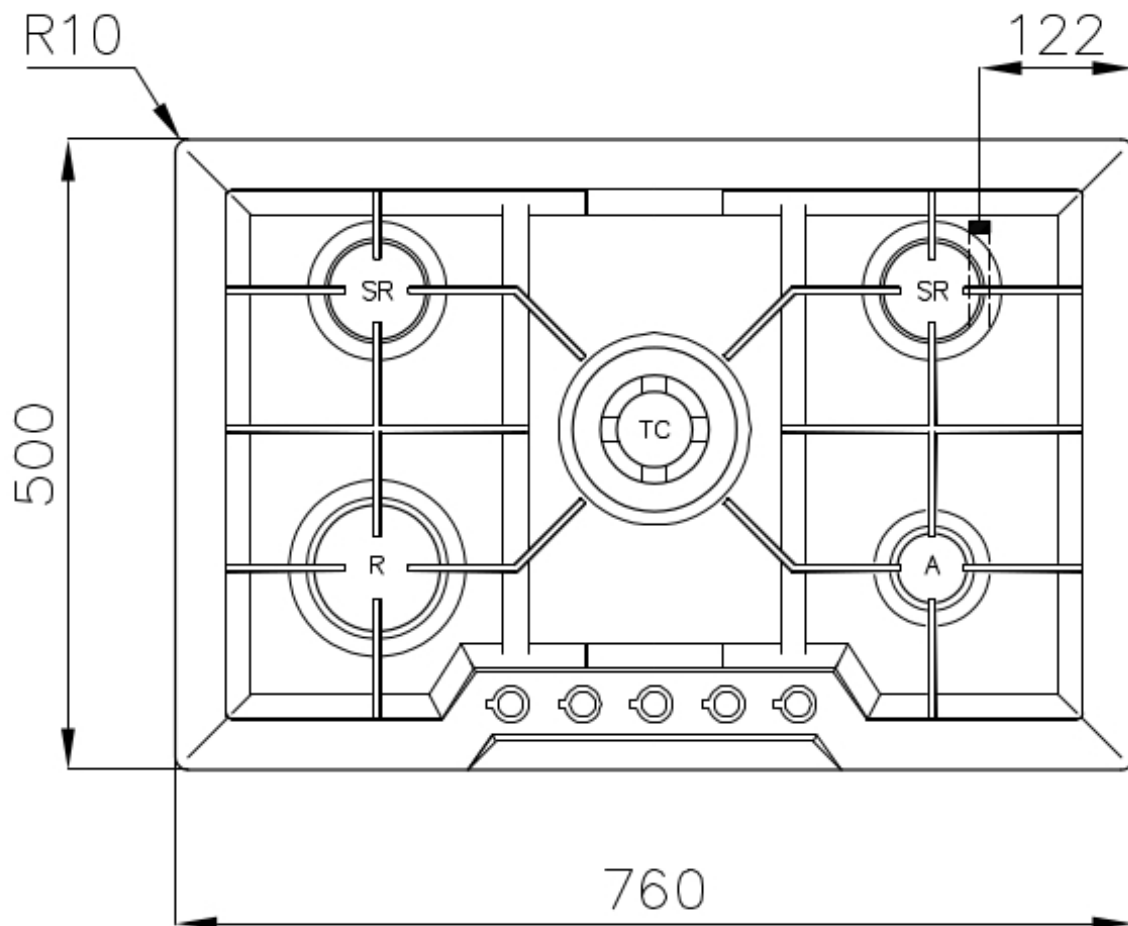
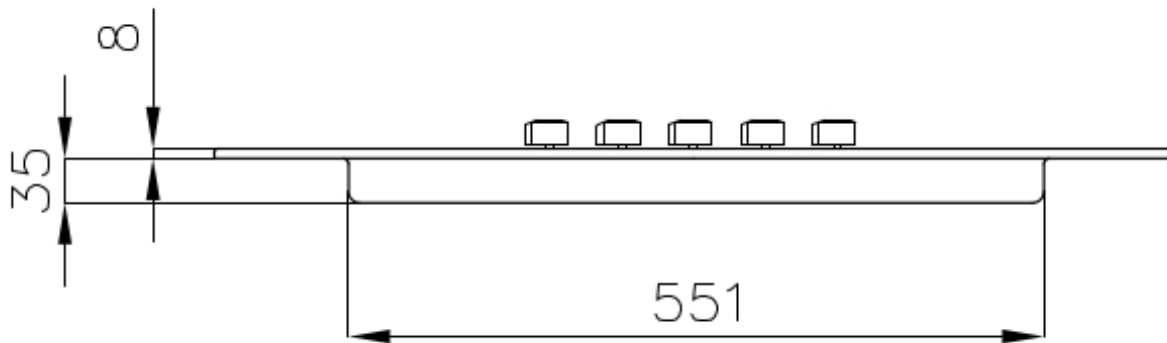

OPTIONAL ACCESSORIES



Cast iron wok support

9601 668